

COUNTRY CLUB PLAZA

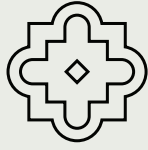

<1,000 SF
OFFICE VACANCIES



For more information, please visit CCPLAZAOFFICE.COM

ADAM ABRAMS, CCIM

913.485.5073 / aabrams@lane4group.com

MIKE LEVITAN

913.220.5014 / mlevitan@lane4group.com

LANE4

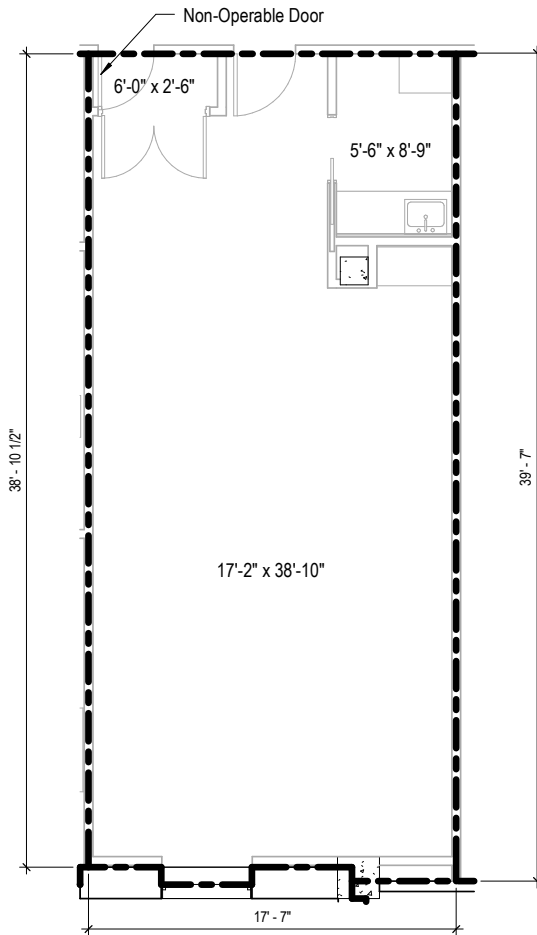

794 SF AVAILABLE - Suite Q208



COUNTRY CLUB PLAZA

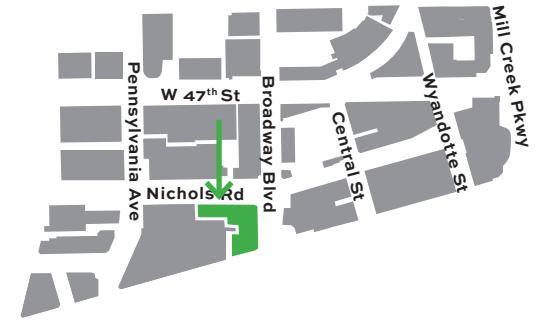

OVERALL FLOOR PLAN

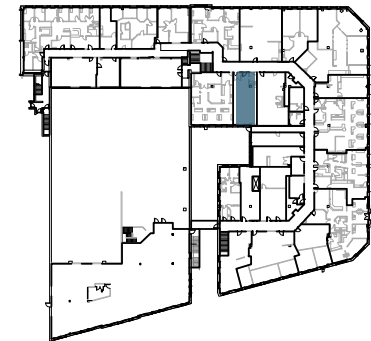

PLAZA TIME BUILDING

411 Nichols Rd

CCPLAZAOFFICE.COM

ADAM ABRAMS, CCIM

913.485.5073 / aabrams@lane4group.com

MIKE LEVITAN

913.220.5014 / mlevitan@lane4group.com



COUNTRY CLUB PLAZA

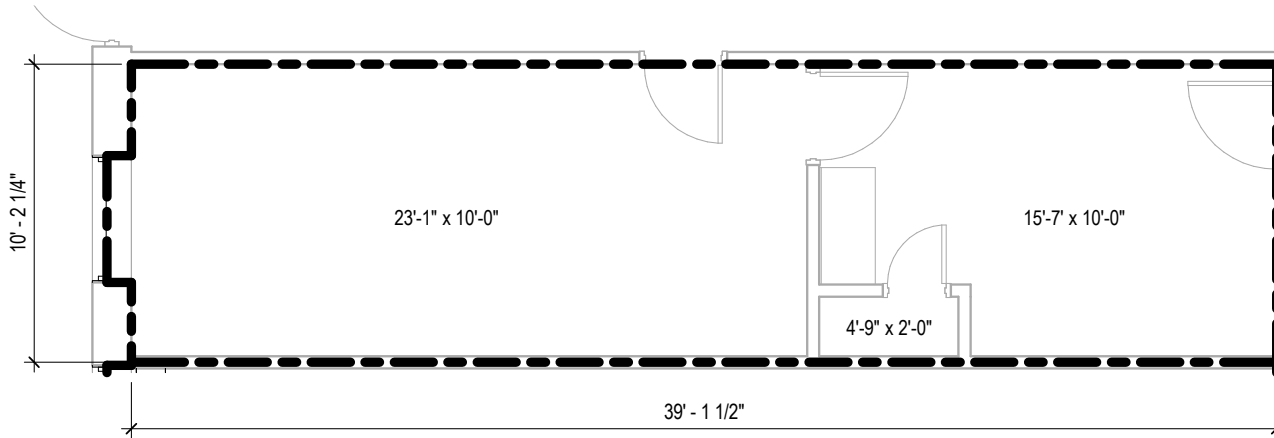
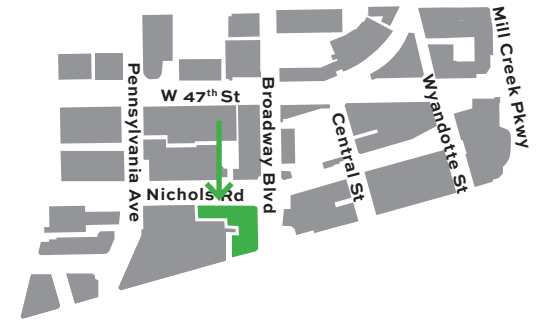

OVERALL FLOOR PLAN

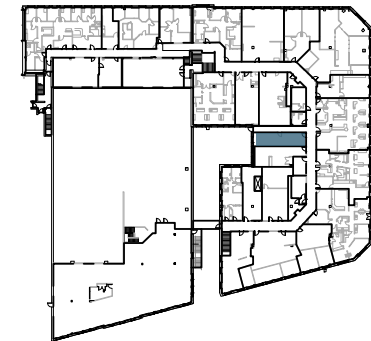

462 SF AVAILABLE - Suite Q235



PLAZA TIME BUILDING

411 Nichols Rd

CCPLAZAOFFICE.COM

ADAM ABRAMS, CCIM

913.485.5073 / aabrams@lane4group.com

MIKE LEVITAN

913.220.5014 / mlevitan@lane4group.com

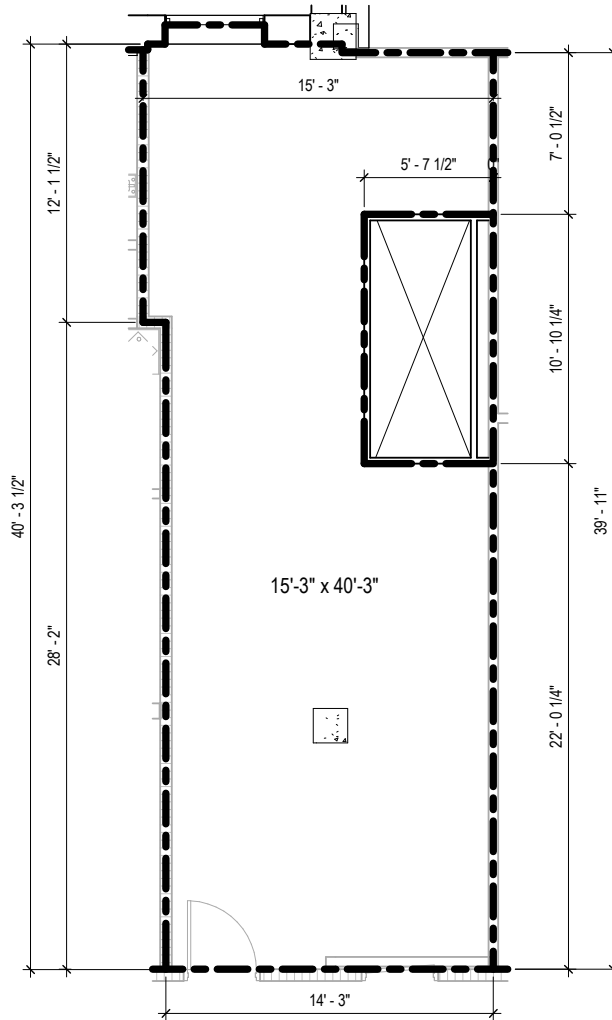

605 SF AVAILABLE - Suite Q251



COUNTRY CLUB PLAZA

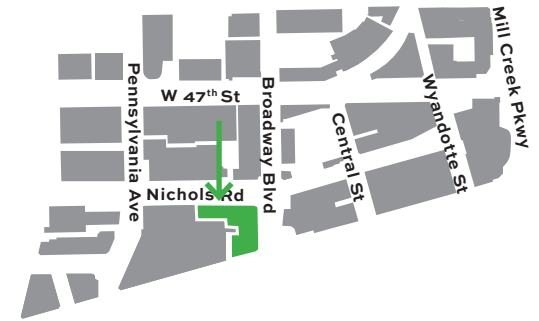

OVERALL FLOOR PLAN

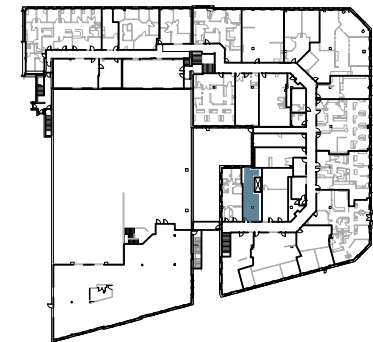

PLAZA TIME BUILDING

411 Nichols Rd

CCPLAZAOFFICE.COM

ADAM ABRAMS, CCIM

913.485.5073 / aabrams@lane4group.com

MIKE LEVITAN

913.220.5014 / mlevitan@lane4group.com

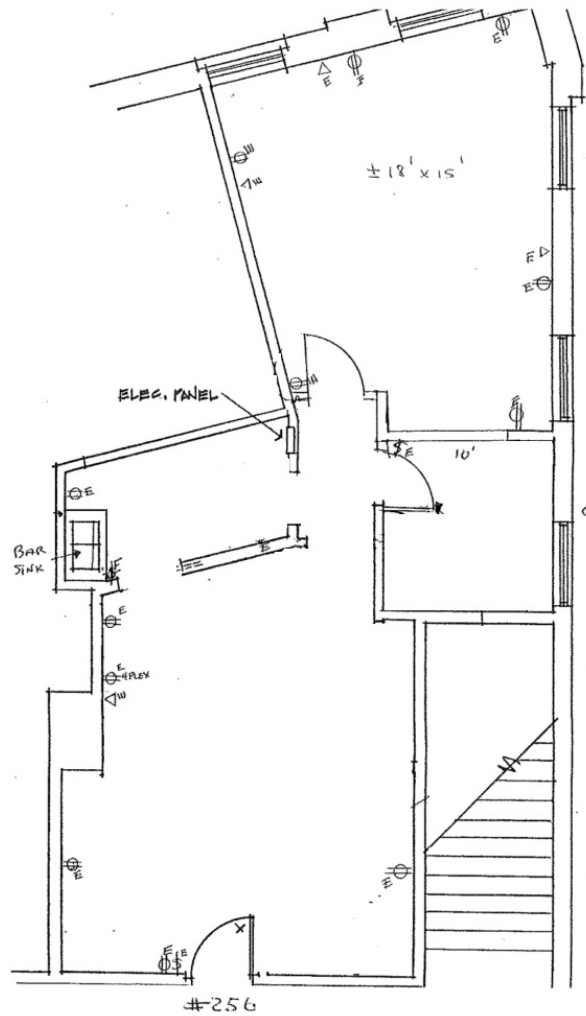

867 SF AVAILABLE - Suite Q256



COUNTRY CLUB PLAZA

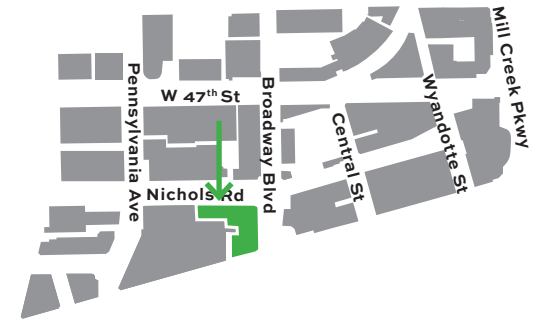

OVERALL FLOOR PLAN

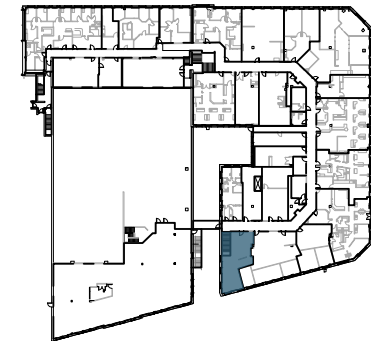

PLAZA TIME BUILDING

411 Nichols Rd

CCPLAZAOFFICE.COM

ADAM ABRAMS, CCIM

913.485.5073 / aabrams@lane4group.com

MIKE LEVITAN

913.220.5014 / mlevitan@lane4group.com

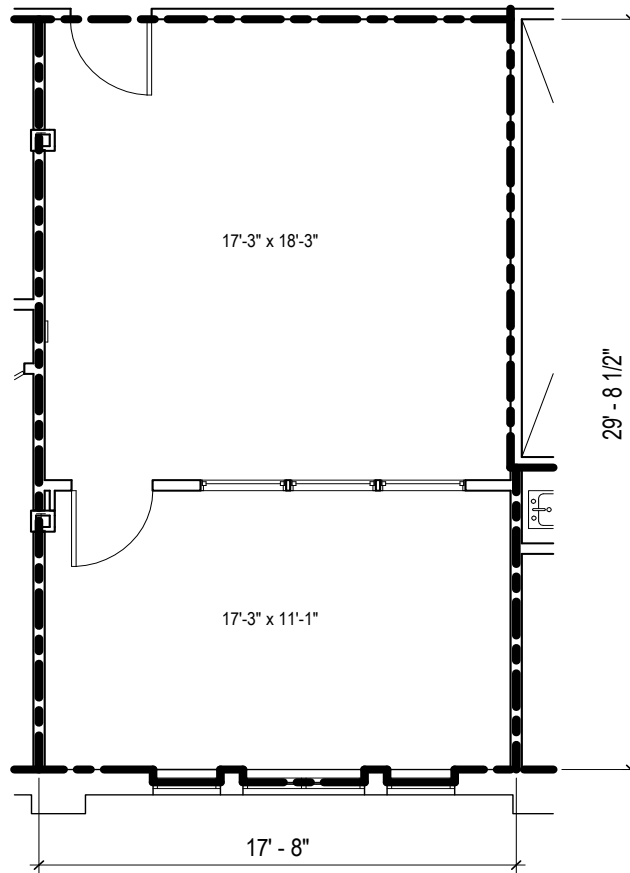

605 SF AVAILABLE - Suite E205Z



COUNTRY CLUB PLAZA

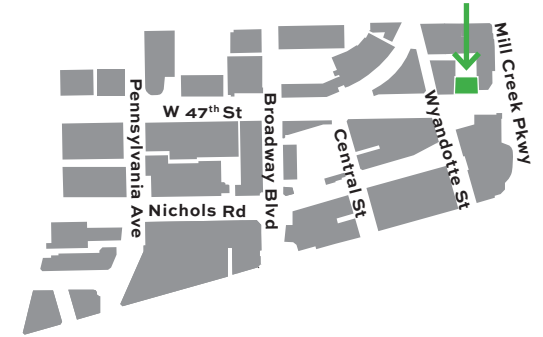

OVERALL FLOOR PLAN

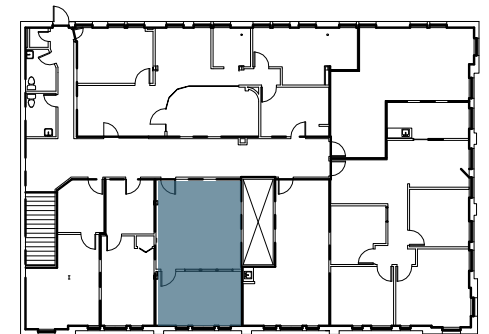

TOWER OFFICE BUILDING

114 W 47th St

CCPLAZAOFFICE.COM

ADAM ABRAMS, CCIM

913.485.5073 / aabrams@lane4group.com

MIKE LEVITAN

913.220.5014 / mlevitan@lane4group.com

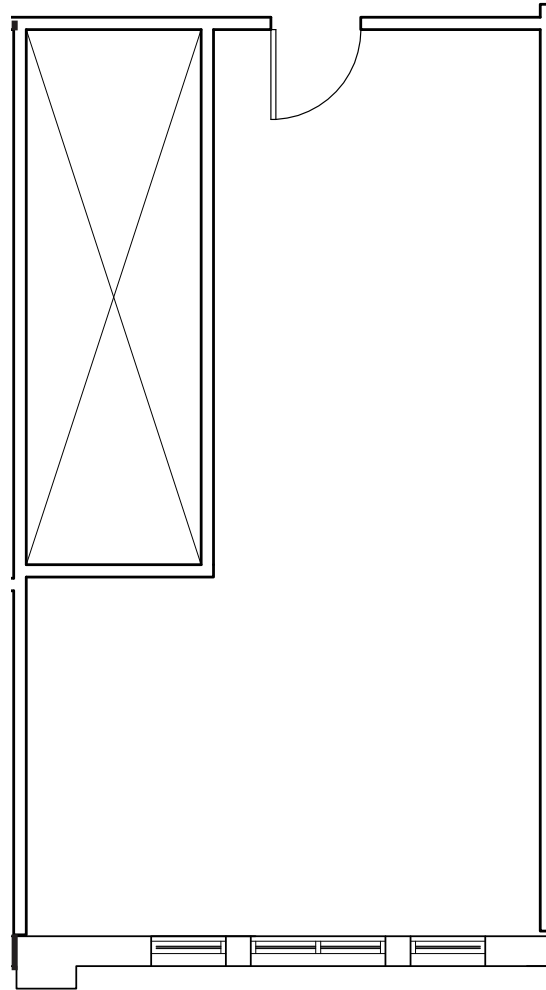

475 SF AVAILABLE - Suite E2090



COUNTRY CLUB PLAZA

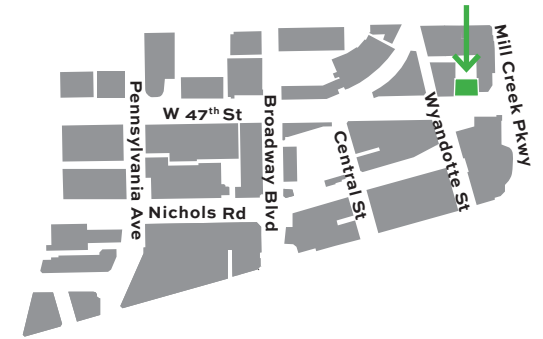

OVERALL FLOOR PLAN

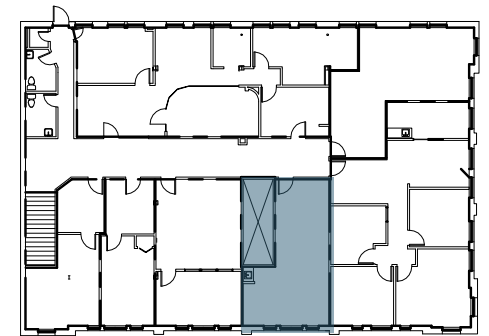

TOWER OFFICE BUILDING

114 W 47th St

CCPLAZAOFFICE.COM

ADAM ABRAMS, CCIM

913.485.5073 / aabrams@lane4group.com

MIKE LEVITAN

913.220.5014 / mlevitan@lane4group.com

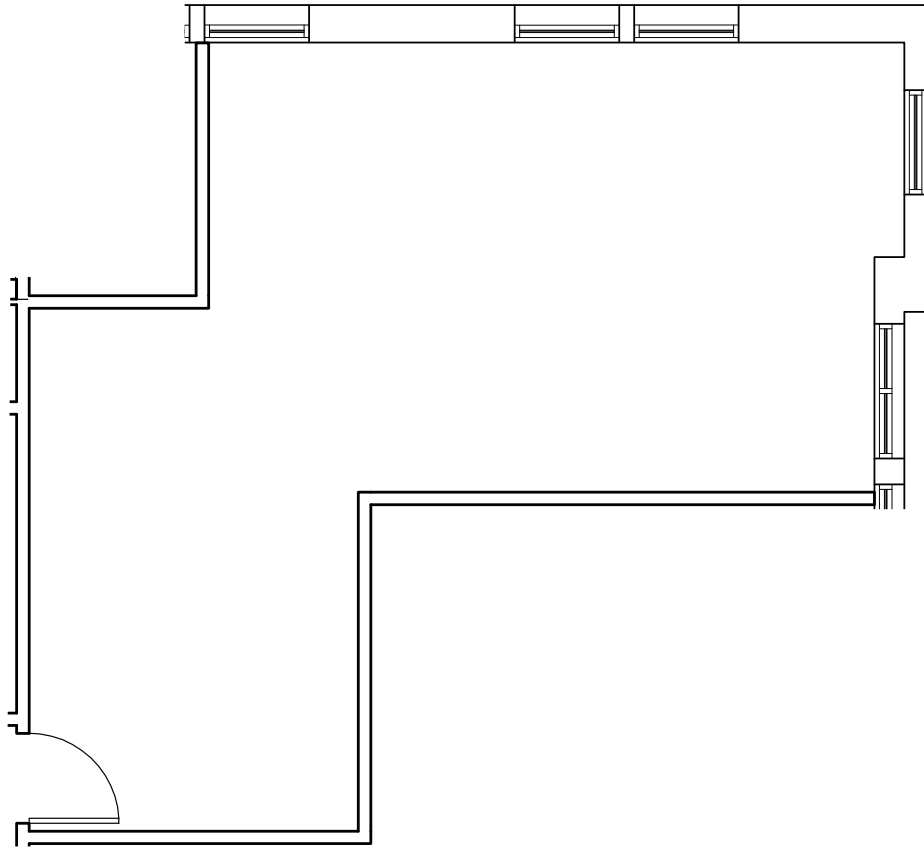

599 SF AVAILABLE - Suite E212



COUNTRY CLUB PLAZA

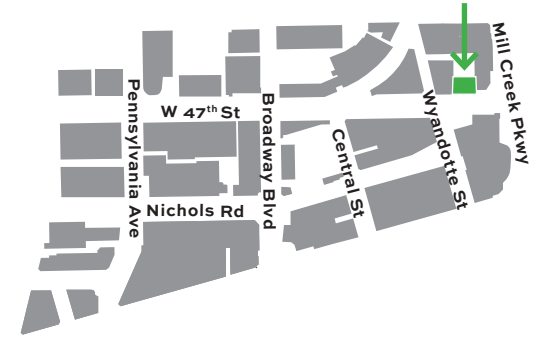

OVERALL FLOOR PLAN

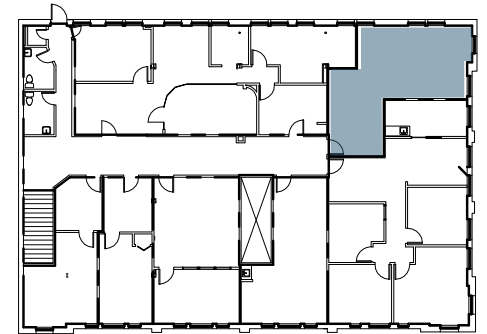

TOWER OFFICE BUILDING

114 W 47th St

CCPLAZAOFFICE.COM

ADAM ABRAMS, CCIM

913.485.5073 / aabrams@lane4group.com

MIKE LEVITAN

913.220.5014 / mlevitan@lane4group.com

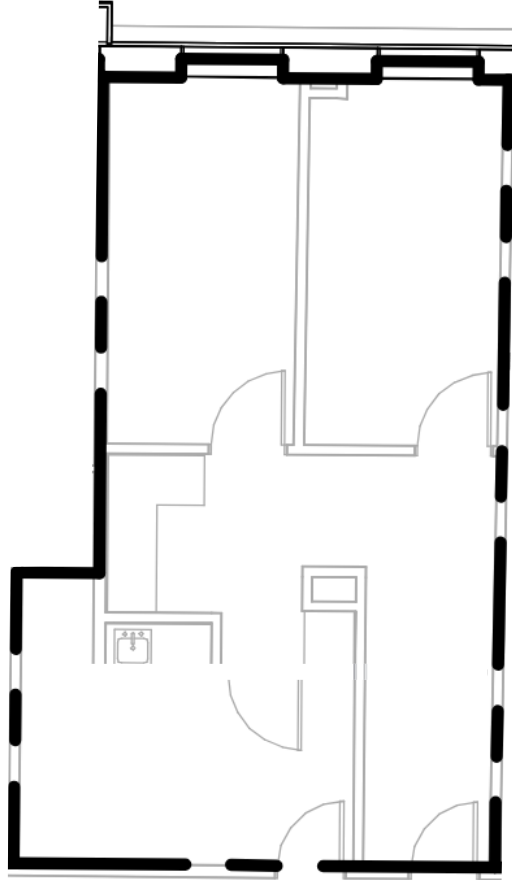

660 SF AVAILABLE - Suite 238



COUNTRY CLUB PLAZA

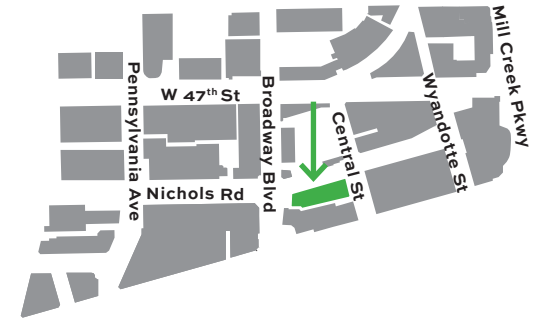

OVERALL FLOOR PLAN



PLAZA MEDICAL BUILDING

315 Nichols Rd

CCPLAZAOFFICE.COM

ADAM ABRAMS, CCIM

913.485.5073 / aabrams@lane4group.com

MIKE LEVITAN

913.220.5014 / mlevitan@lane4group.com

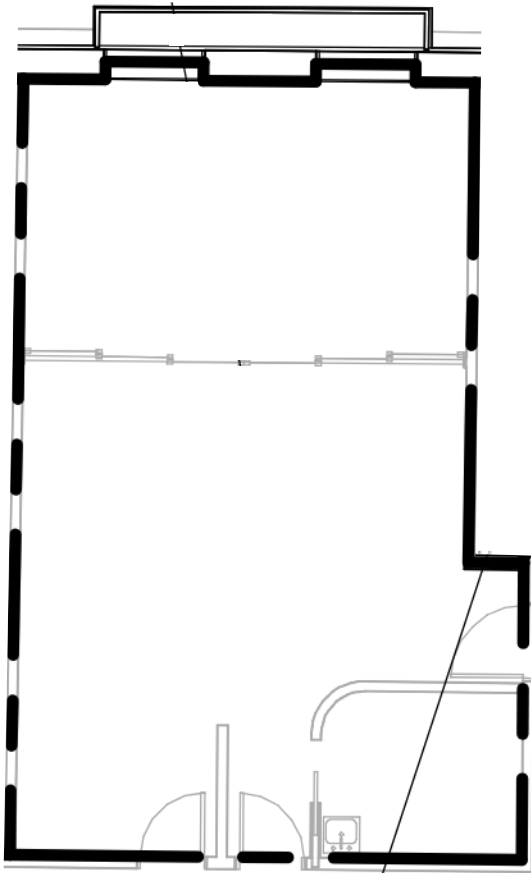

736 SF AVAILABLE - Suite 236

Available 6/1/2026



COUNTRY CLUB PLAZA

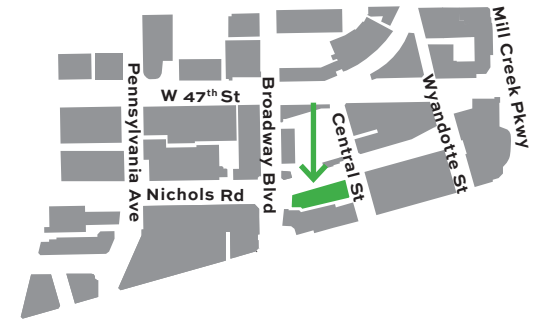

OVERALL FLOOR PLAN

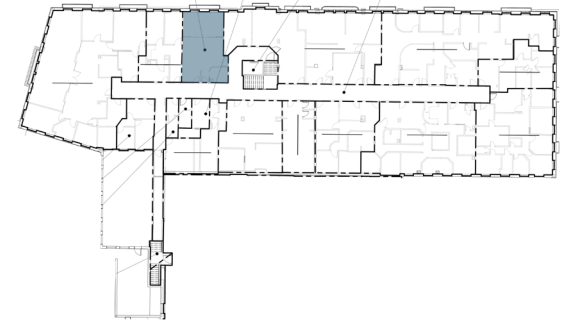

PLAZA MEDICAL BUILDING

315 Nichols Rd

CCPLAZAOFFICE.COM

ADAM ABRAMS, CCIM

913.485.5073 / aabrams@lane4group.com

MIKE LEVITAN

913.220.5014 / mlevitan@lane4group.com



BUILDING & ADDRESS

- 1 Time West Building / 435 Nichols Rd
- 2 Plaza Time Block / 411 Nichols Rd
- 3 Cordoba Building / 460 Nichols Rd
- 4 Esplanade Building / 4706 Broadway Blvd
- 5 Plaza Medical Building / 315 Nichols Rd
- 6 Nichols Building / 310 Ward Pkwy
- 7 Theatre Block / 4705-4717 Central St
- 8 Tower Building / 116 W 47th St
- 9 Mill Creek Building / 4638 Millcreek Pkwy
- 10 Balcony Building / 312-340 W 47th St

OFFICE AT THE COUNTRY CLUB PLAZA



COLOR KEY

- Office
- Parking
- Retail & Restaurant